

INDEX

TENSION FABRIC SYSTEMS

SOHO Fabric walls	3-4
Stand Off, Oval Counter, Accessories	5
T Stand, S Stand, AE Stand	6
Roll Ups, Table Tops	7

POP UPS

FAB Fabric Pop Up	8
FAB Stretch Pop up	9

FABRIC HANGING SIGNS 10-11

AE FRAME SYSTEMS 12-13

FABRIC LED LIGHT BOX 14-15

FLAGS 16

POP UP CANOPIES 17

CUSTOMIZATION 18-19



SOHO TENSION FABRIC SYSTEMS

SOHO tensioned-fabric structures are fabulous portable displays for trade shows, events, and meetings. Sleek, light weight and sturdy, aluminum frames are constructed of 1-1/2" diameter silver powder coated tubing. Assemble in minutes with indicated labels. Covered with premium quality stretch fabric slip covers, SOHOs are quick and easy to put together. SOHO comes in varieties of stylish shapes and sizes to suit your individual needs and preferences. SOHO can be combined with podiums, stand off packages and accessories to create a complete look.

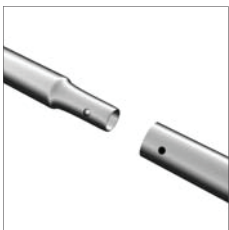

Push Button Joint

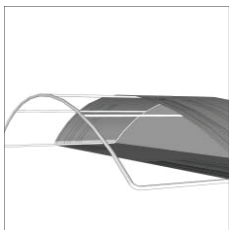

Pillowcase Mount



Zipper Closure

- Sleek, Light weight, sturdy frames
- Extremely easy to set up, pillow case covers with a zipper closure
 - Premium quality dye sub prints from your artwork
 - "Wrinkle Free" stretch fabric slip covers
 - Available in varieties of stylish shapes and sizes
 - Soft travel bag included with every frame
 - Graphics are available 1 sided & 2 sided
 - Custom sizes available



SOHO FABRIC WALLS



SOHO20

SOHO10

SOHO8

HORIZONTAL CONCAVE

Model	Width	Height	Depth	Wt(lbs)
SOHO8	96"	94"	24"	24
SOHO10	117"	94"	24"	26
SOHO20	236"	94"	35"	46



SOHOF20

SOHOF10

SOHOF8

FLAT

Model	Width	Height	Depth	Wt(lbs)
SOHOF8	96"	96"	2"	25
SOHOF10	111"	96"	2"	29
SOHOF20	230"	96"	2"	52

■ Stabilizing feet size: 7" x 18"



SOHOS20

SOHOS10

S WAVE

Model	Width	Height	Depth	Wt(lbs)
SOHOS10	118"	94"	24"	26
SOHOS20	226"	94"	32"	47



SOHOV10

VERTICAL CONCAVE

Model	Width	Height	Depth	Wt(lbs)
SOHOV10	117"	91"	24"	29

STAND OFF • OVAL COUNTER • ACCESSORIES

STAND OFF

- Features a straight stand-off that allows for adding a monitor, removable fabric graphics or attractive shelving.

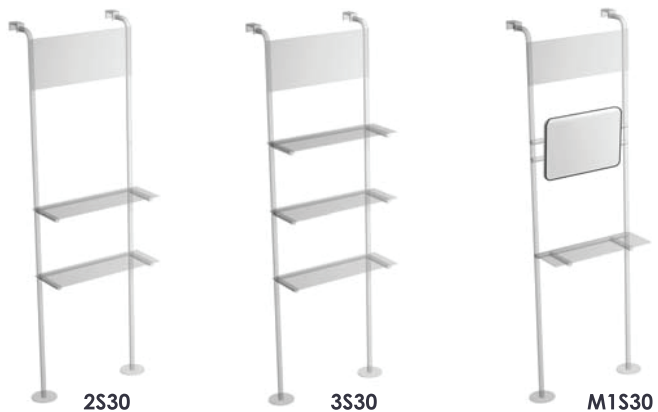

Model	Width	Height	Depth	Wt(lbs)	Kit
3S30	30"	94"	10"	22	3 shelves
2S30	30"	94"	10"	18	2 shelves
M1S30	30"	94"	10"	14	1 shelf, 1 monitor bracket



OVAL COUNTER

- Interior shelf accessible with convenient zipper located in the back of the counter graphic
- Padded travel bag Included

Model	Width	Height	Depth	Wt(lbs)
FOC	31"	39"	17"	24



ACCESSORIES

HARD CASES

- Strong wheeled hard cases are designed for convenient storage and easy transport



SQ-12
12" x 12" x 39"
wt: 13 lbs



SQ-16
16" x 17" x 39"
wt: 22 lbs

SPOT LIGHTS

- 50W low voltage halogen light
- LED light bulb available
- Easy clamp on system



HI50



HI60

T STAND • S STAND • AE STAND

T STAND • S STAND

- Slim, Lightweight yet sturdy frames
- Dye sub printed "Wrinkle Free" stretch fabric slip covers
- Extremely easy to set up pillow case graphics
- Graphics are available 1 sided & 2 sided



TS38



TS35



SS38



TS338

Model	Width	Height	Depth	Wt(lbs)
TS38	36"	92"	2"	15
TS35	36"	92"	2"	15
TS338	108"	92"	2"	60
SS38	36"	92"	6"	15

▪ Stabilizing feet size: 4" x 18"



EVA CASE

AE STAND

- Sleek, frameless clean appearance
- Easy installation with interchangeable graphics
- "Wrinkle Free" dye sub printed fabric graphics
- Graphics are available 1 sided & 2 sided
- Custom sizes available

Model	Width	Height	Depth	Wt(lbs)
AE26FS	24"	72"	2"	20
AE37FS	36"	84"	2"	30

AE26FS



AE37FS



ROLL UP STANDS • TABLE TOPS

ROLL UP STANDS

- Outstanding quality non-curling graphics
- Free soft travel bag included with every unit
- Slim, lightweight
- Quick and easy setup



RU31
31.5" x 79"
wt: 10 lbs



RU33
33.5" x 86"
wt: 13 lbs



RU47
47" x 86"
wt: 13 lbs

TABLE TOPS

- Sleek, lightweight and sturdy
- Premium quality dye sub prints from your artwork
- Quick and easy to set-up
- Available in varieties of stylish shapes



SOHO-TT
69" x 44" x 11"
wt: 7 lbs

- Horizontal Concave
- Pillow case Mount



AE45-TT
69" x 44" x 2"
wt: 20 lbs

- Frameless Look
- Keder Mount



LB-TT
69" x 44" x 4"
wt: 30 lbs

- LED back lit
- Keder Mount

FAB FABRIC POP UP

- Lightweight & portable
- "Wrinkle Free" graphics stays attached to frame
- Extremely easy to set up, no tools required
- Graphic available for Front only, front & end caps, Wrap around

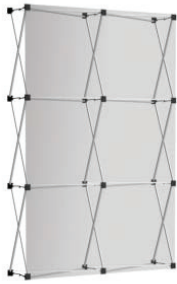
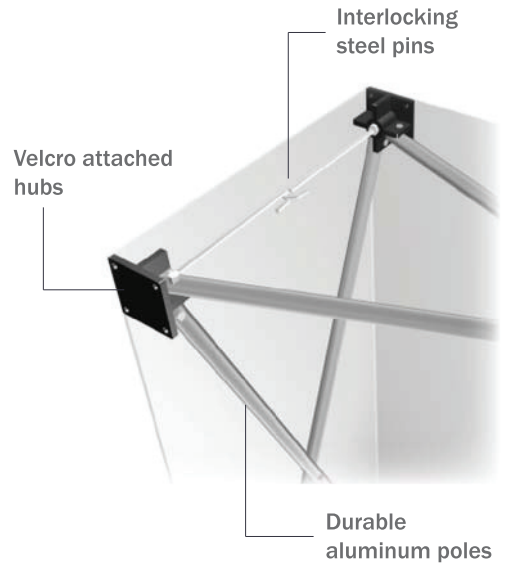

POP23

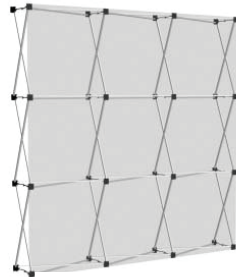

POP33

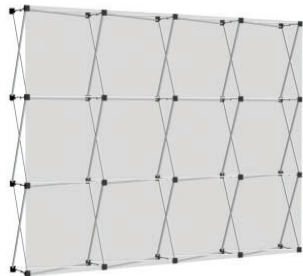

POP43

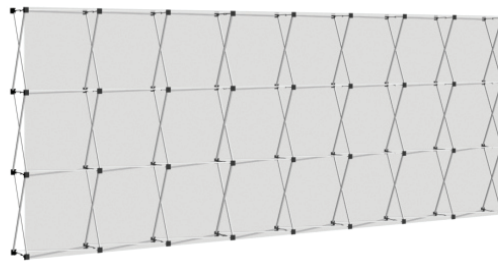

POP83

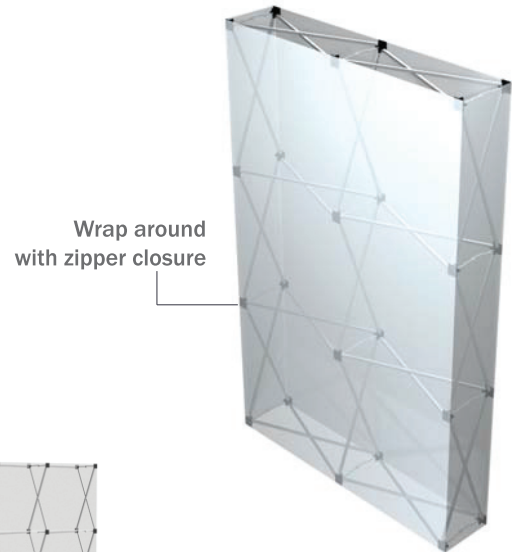

Model	W x H Quads	Width	Height	Wt(lbs)
POP23	2 x 3	59"	88.5"	25
POP33	3 x 3	88.5"	88.5"	31
POP43	4 x 3	118"	88.5"	40
POP53	5 x 3	147.5"	88.5"	49
POP83	4 x 3 (2 units)	238"	88.5"	80

- Each quad is approximately 29.5" x 29.5"
- Custom size available

FAB STRETCH POP UP

- Extremely eye-catching
- Quick & easy set up without tools
- Create 3D effects
- Numerous configurations



SP-13K1

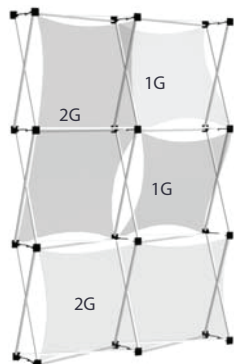

SP-23K1

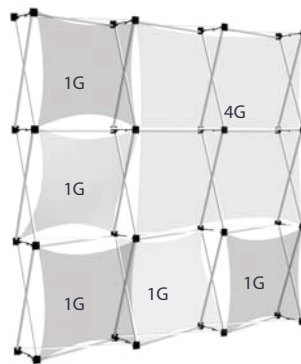

SP-33K1

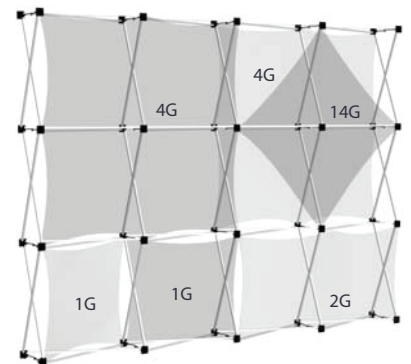

SP-43K1

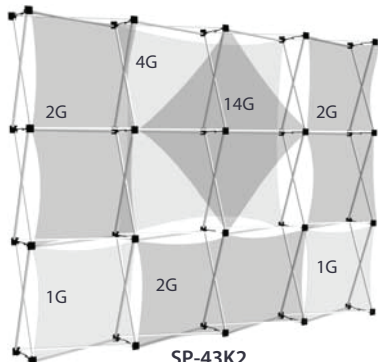

SP-43K2

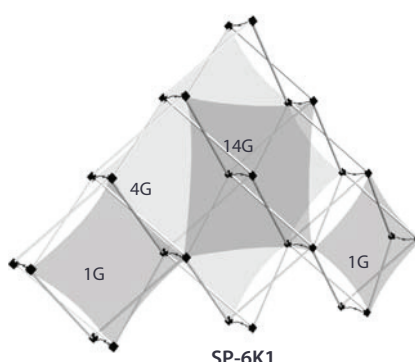

SP-6K1

Model	W x H Quads	Width	Height	Wt(lbs)	Kit
SP-13K1	1 x 3	29.5"	88.5"	15	1-1G, 1-2G
SP-23K1	2 x 3	59"	88.5"	25	2-1G, 2-2G
SP-33K1	3 x 3	88.5"	88.5"	31	5-1G, 1-4G
SP-43K1	4 x 3	118"	88.5"	40	2-1G, 3-2G, 1-14G, 2-4G
SP-43K2	4 x 3	118"	88.5"	40	2-1G, 1-2G, 1-14G, 1-4G
SP-5K1	5	83"	83"	23	5-1G
SP-6K1	6	125"	83"	25	2-1G, 1-14G, 1-4G

- Each quad is approximately 29.5" x 29.5"
- Custom size available





FABRIC HANGING SIGNS

- Available in varieties of distinct shapes and sizes
- Premium quality dye sub fabric graphics
- Single and double sided printing available
- Pillowcase graphic with easy zippered set up
- Available with custom sizes
- Comes with padded nylon carry bag



Push Button Joint

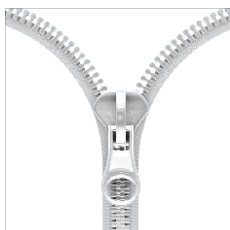

Zipper Closure





CIRCLE

Diameter (ft)	6, 8, 10, 12, 14, 16, 18, 20
Height (inch)	24", 30", 36", 42", 48"



TAPERED CIRCLE

Diameter (ft)	10, 12, 14, 16, 18, 20
Height (inch)	36", 42", 48"



FOOTBALL

Diameter (ft)	10, 12, 16, 20
Height (inch)	36", 42", 48", 60"



PIN WHEEL

Diameter (ft)	10, 12, 16, 20
Height (inch)	36", 42", 48", 60"

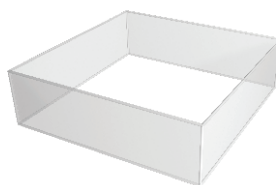

SQUARE

Diameter (ft)	6, 8, 10, 12, 14, 16, 18, 20
Height (inch)	30", 36", 42", 48"



TAPERED SQUARE

Diameter (ft)	10, 12, 16, 20
Height (inch)	30", 36", 42", 48"



TRIANGLE

Diameter (ft)	6, 8, 10, 12, 14, 16, 18, 20
Height (inch)	30", 36", 42", 48"



TAPERED TRIANGLE

Diameter (ft)	10, 12, 16, 20
Height (inch)	30", 36", 42", 48"



CURVED TRIANGLE

Diameter (ft)	10, 12, 16, 20
Height (inch)	30", 36", 42", 48"



Rotator



Fabric Carrying Bag



HC50

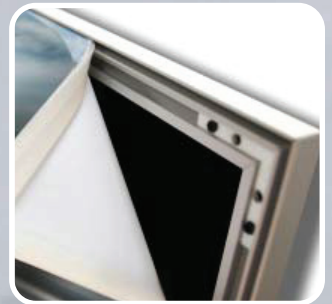

AE FRAME SYSTEMS

AE Frame is the ideal frame system for creating fabulous visual effects. A custom dye sub printed fabric uses Keder and allows for easy of installation with interchangeable graphics. A sleek, modern frameless clean appearance that blends into every environment. AE Frame allows 1 sided or 2 sided graphics which can be mounted on the wall, suspended from the ceiling, or used as a free-standing display. AE Frames comes in varieties of thicknesses and sizes to suit your individual's needs and preferences.

- Sleek, modern, frameless Look
- Made of high quality aluminum profile system
- Lightweight yet sturdy
- Silver anodized extrusion frame
- "Wrinkle Free" dye sub printed fabric graphics with silicon strips
- Easily interchangeable graphics

AE15

Ultra Thin
5/8 inch (15mm) wide aluminum profile
Single sided graphic

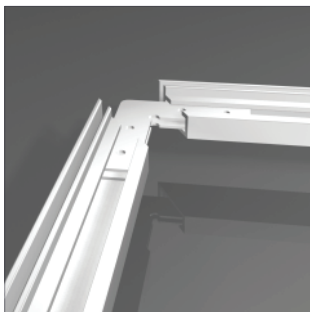

WALL MOUNT



AE45

1 3/4 inch (45mm) wide aluminum profile
Single sided or double sided graphic
Wall mount, free standing, ceiling hung

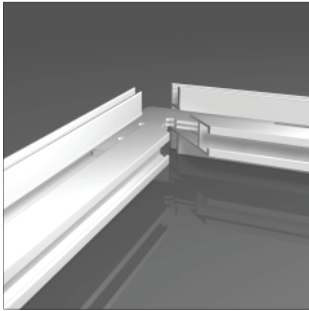

FREE STANDING



AE37FS



WALL MOUNT



FREE STANDING



CEILING HUNG

WALL MOUNT

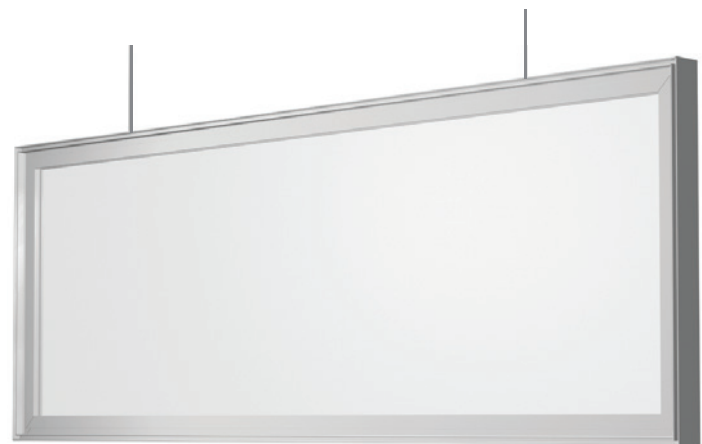

CEILING HUNG



FABRIC LED LIGHT BOX

The Fabric LED Light Boxes provide epic solutions to enhance your image. The light box is illuminated by the long lasting, energy saving LED technology. The LED provide bright, uniform illumination using edge lit technology that combines with a dye sub print on specialty light box fabric to provide a sleek, frameless clean look. The light boxes can accommodate 1 sided or 2 sided graphics which can be mounted on the wall, suspended from the ceiling, or used as a free-standing display. Fabric LED Light Box comes in varieties of thicknesses and sizes to suit your individual needs and preferences. The Fabric LED Light Boxes are ideal for retail shops, museums, trade shows and literally blends into every environment.

- Unique, modern, frameless look
- Made of high quality aluminum profile system
- Lightweight yet sturdy
- LED edge lit technology
- Dye sub printed fabric graphics with silicon strips
- Easily interchangeable graphics

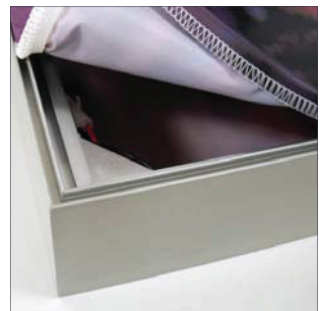
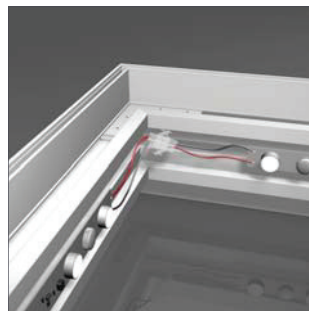
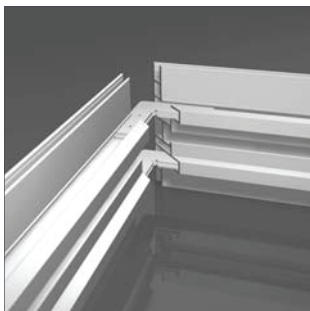

LB100

4 inch(100mm) wide aluminum profile
Single or double sided graphic
LED edge lit
Wall mount, free standing



WALL MOUNT

FREE STANDING



LB150

6 inch (150mm) wide aluminum profile
Double sided graphic
LED edge lit
Wall mount, free standing, ceiling hung

CEILING HUNG

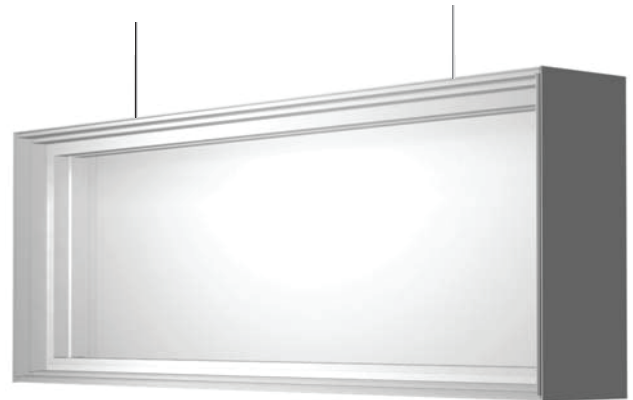

WALL MOUNT



FREE STANDING



FLAGS

Flags are a unique and stylish way of adding a bit of flare to your displays. Light as well as aesthetically pleasing, flags make for excellent displays both indoors as well as outdoors. These portable flag options are lightweight and easy to set up in minutes. Water resistant flag material using dye sublimation inks ensures lasting durability.

- Unique, instant visibility
- Eye-catching motion
- Perfect for indoor and outdoor events
- Quick and easy assembly
- Premium quality dye sub prints
- Graphics are available single or double sided



Poles & padded bag



Cross base



Cross base with water bag



Ground stakes

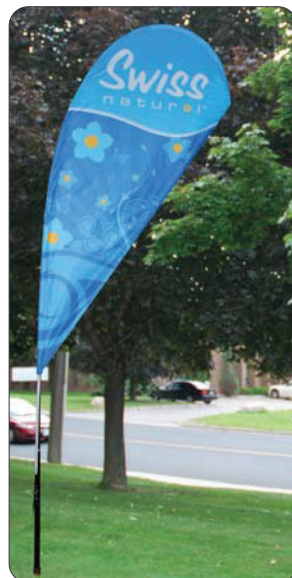

POP UP CANOPIES

The 10x10 pop up frame accomodates full color custom printed canopy graphics including the top, walls, side skirts. The lightweight rust proof frame is easy to set up in minutes using velcro tabs to attach the graphics. This weather resistant canopy option is a great portable solution for your next outdoor event.

- Durable hex. aluminum frames
- Instant set up and take down
- Custom prints on canopy tops, walls & side skirts
- Wind and water resistant
- Premium quality dye sub prints
- Great for outdoor events



Peaks & valances



Peak & valances , back wall, side skirts



ROLLER BAG WITH WHEELS



Peak & valances , back & side walls

CUSTOMIZATION

Customizations blend the infinite possibilities of unique designs, functions and features of displays to suit your individual needs and preferences. Quality, efficiency and practicality are set to standard and integrated in building to maximize the benefits of durable and lightweight systems.

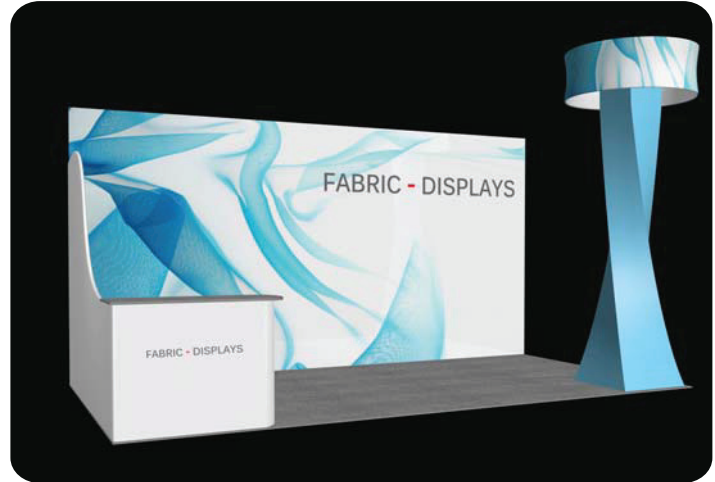

INNOVATIVE IDEAS!

- Your idea to invention
- Practically built to use
- Cost efficient solutions





INFINITE POSSIBILITIES!

- Creative solutions to suit individual needs and preferences
- Thorough quality controlled production
- 3D renderings available

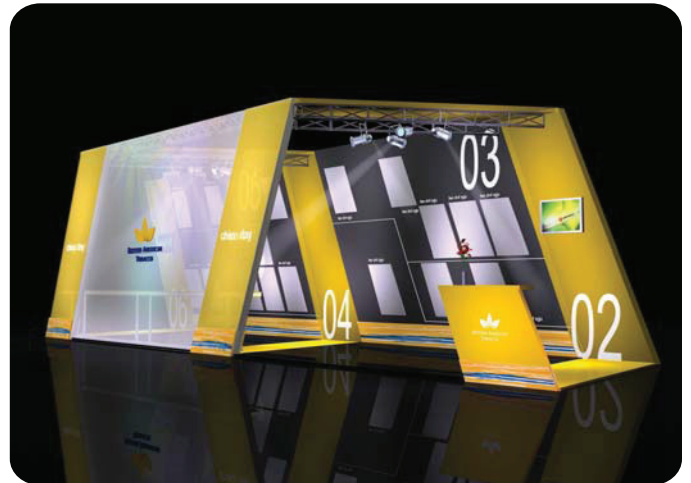



www.ImageGraphics.ca

Tel: 519-659-8846